

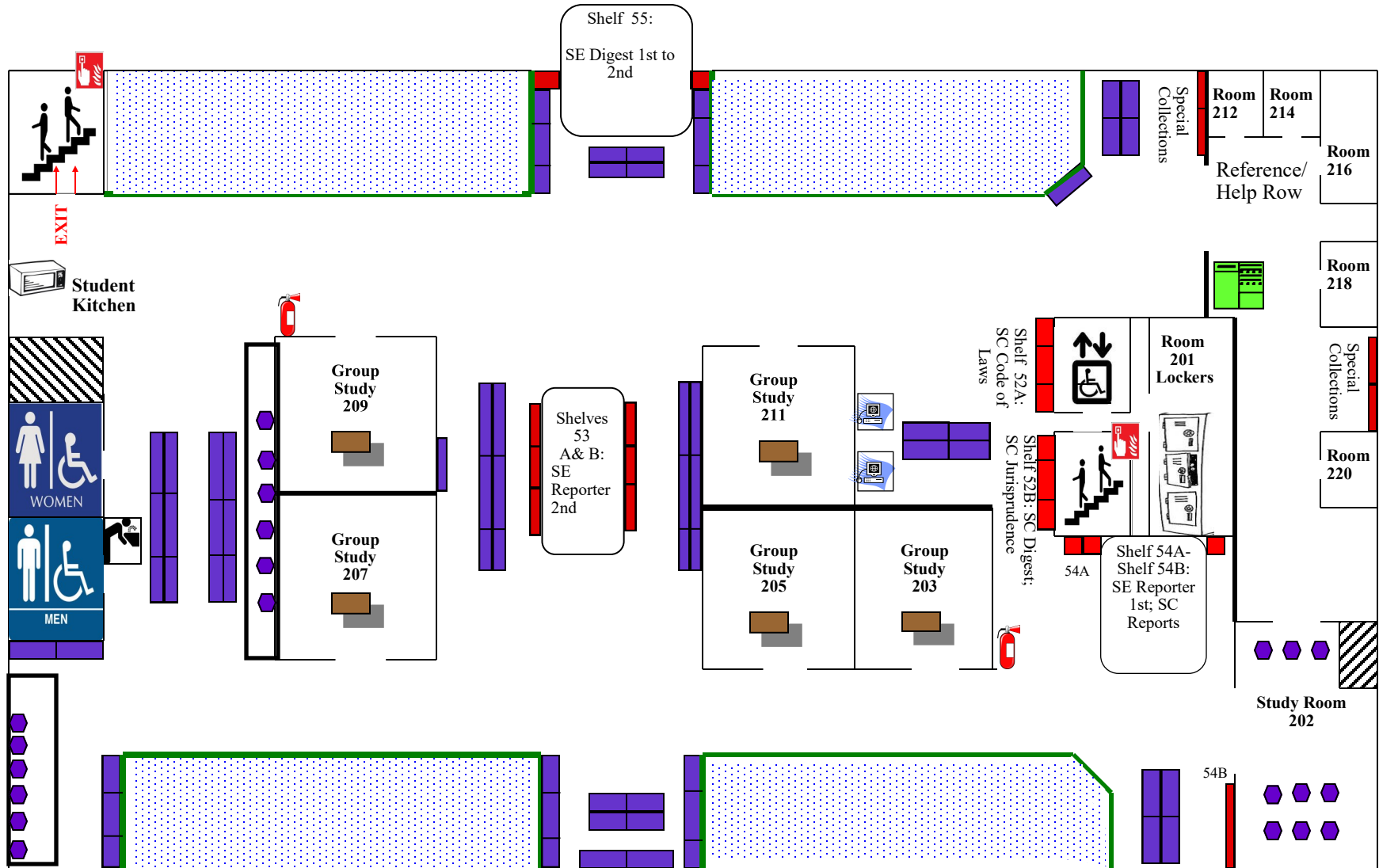









# Sol Blatt Jr. Law Library, Second Floor



## 2nd Floor Map Key

 Staff Only  Individual Study  Study Carrels	 Student Printer  Patron Access Terminal	 Elevator  Stairs	 Fire Extinguisher  Fire Alarm
---	---	--	---